



OFA SKY Q REPLACEMENT REMOTE

UNIVERSAL REPLACEMENT REMOTE URC 1635 SIMPLE SET UP GUIDE

WELCOME 2

INSERT BATTERIES 2

KEY TABLE 3

LED COLOUR 4

HOW TO SET UP YOUR REMOTE 4

A - SIMPLESET 5

B - SETUP BY CODE 7

C - LEARNING 9

SPECIAL FEATURES 11

KEY MAGIC 11

CHANNEL SHORTCUT MACROS 14

HDMI SELECTION 15



WELCOME, PREPARE YOUR REMOTE FOR INSTALLATION

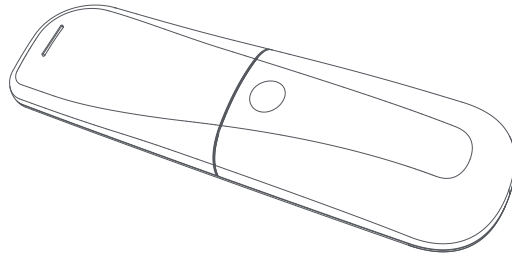

OPEN THE BATTERY DOOR.

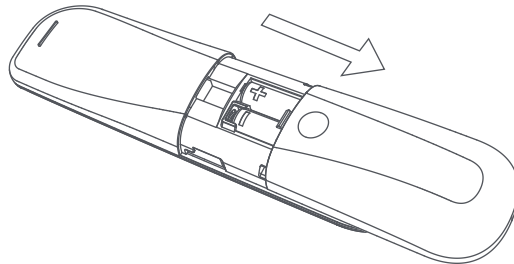

INSERT 2 AAA BATTERIES.

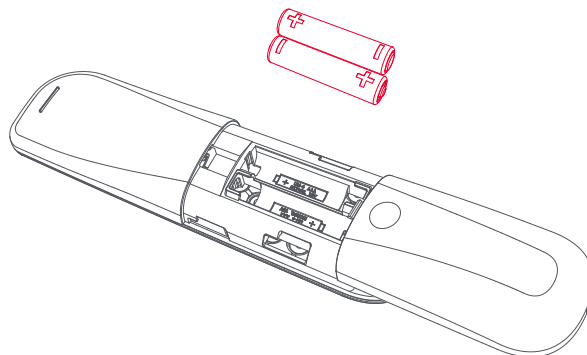

CLOSE THE BATTERY DOOR.

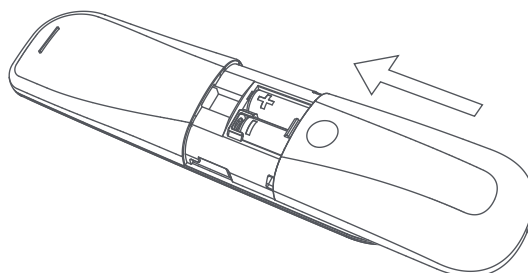

Thank you for purchasing the One For All UHD Remote.

This remote is intended as a replacement for the Sky Q Infrared remote control, and also offers the functionality of controlling the volume and power of your TV or Sound Bar / Audio Video Receiver. The remote also features handy shortcut macros for easy channel zapping and a powerful all on/off macro.

KEY TABLE

1. TV Power – Switches TV on and off. TV must be set up first – see Setup
2. TV Input – used to select the correct HDMI input on your TV. TV must be set up first – see Setup
3. Power – Switches Sky box on and off.
4. SKY – Opens Recordings / Menu
5. ? – Help info / Accessibility settings
6. i – More info
7. Search – Search for a specific show
8. Rewind – Press repeatedly to increase speed
9. Play/pause
10. Fast forward – Press repeatedly to increase speed

11. Navigation and OK (select) buttons
12. Back/Dismiss – Exits menus or recorded show
13. Home – Home Screen
14. ... – Opens sidebar / options
15. Volume up, down and mute. Can be reassigned to TV or Sound Bar / AV Receiver – see Setup
16. R – Record
17. Channel up/down
18. Coloured buttons – Interactive services. Can also be used for channel shortcuts – see Channel Shortcuts
19. 0-9 – Type in channel numbers

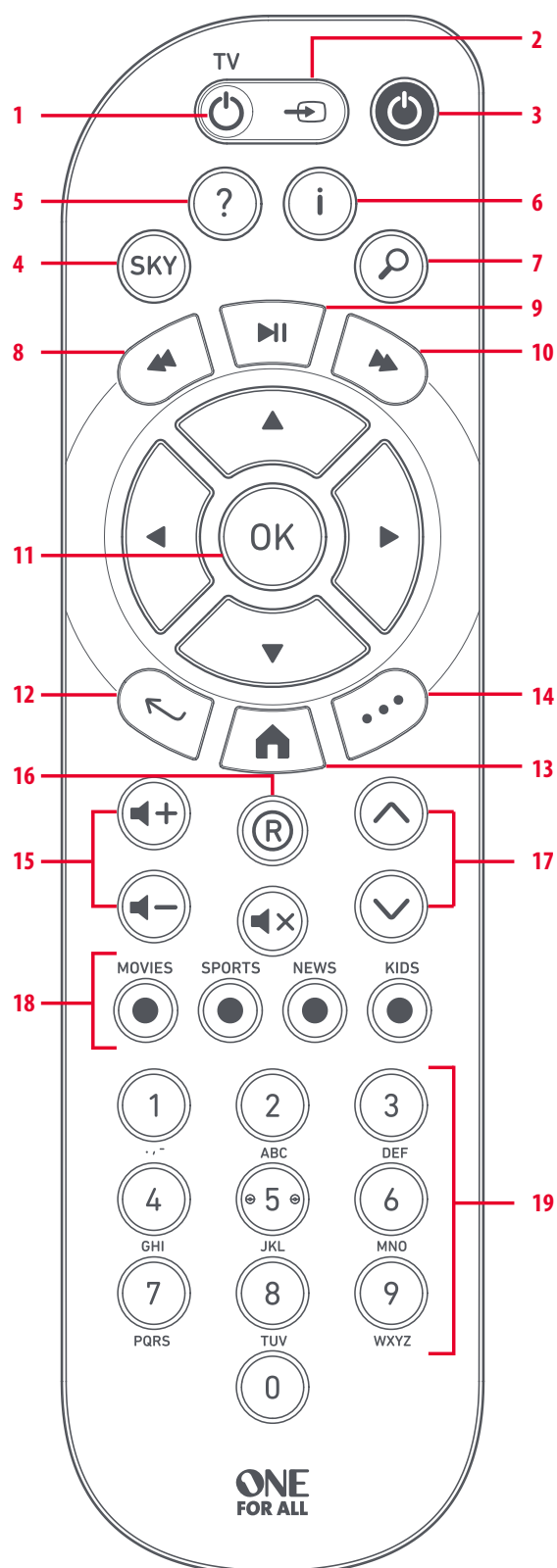

LED COLOUR



Under the Power key there is a three colour LED, which helps to show which device you are controlling as well as helping you to set up your remote. The following colours indicate which device is being controlled or set up:

Green

– TV

Amber

– Sound Bar / Audio Video Receiver

Red

– Sky / Media Box

HOW TO SET UP YOUR REMOTE

SETUP

The OFA UHD remote is pre-programmed to control your Sky Q box, just insert batteries and it will work directly. However it can also be programmed to control the Volume, Mute, Input and Power of your TV, and if required, the Volume and Mute of your Sound Bar. If you have a different Sky box or a Digital Media box such as a Now TV or Apple TV, you can also set this up in place of the Sky Q.

You can set up these devices on your remote as follows:

HOW TO SET UP YOUR REMOTE

A - SIMPLESET

If the brand of your device is shown below, you can use the SimpleSet system described on the next page:

If the brand of your device is not shown, please proceed to section B - SETUP BY CODE.

TV

- 1 Bush
- 2 Grundig
- 3 LG
- 4 Panasonic
- 5 Philips
- 6 Samsung / Sharp
- 7 Sony
- 8 TCL / Thomson
- 9 Toshiba



Sound Bar / Audio Receiver

- 1 Bose
- 2 Denon
- 3 LG
- 4 Marantz
- 5 Onkyo
- 6 Panasonic / Philips
- 7 Pioneer
- 8 Samsung
- 9 Sony
- 0 Yamaha



Other Sky / Digital Media Box (not necessary for Sky Q)

- 1 Apple
- 2 A C Ryan
- 3 Asus
- 4 Dune
- 5 iOmega
- 6 Microsoft
- 7 Roku
- 8 Sky
- 9 Sony
- 0 Western Digital



HOW TO SET UP YOUR REMOTE

To set up your device:

1. Turn on your device (not on standby) and point the OFA remote towards it.
2. To set up:

TV

Hold down TV Power and SKY Power until the Green LED under the Power key blinks twice.

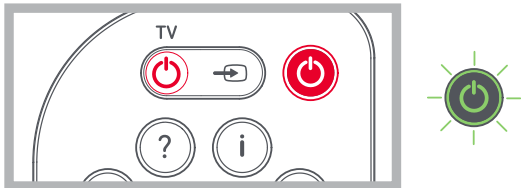

AUDIO, RECEIVER, SOUND BAR

Hold down Volume + and Volume - until the Amber LED under the Power key blinks twice.



OTHER SKY / DIGITAL MEDIA BOX

Hold down Channel + and Channel - until the red LED under the Power key blinks twice.

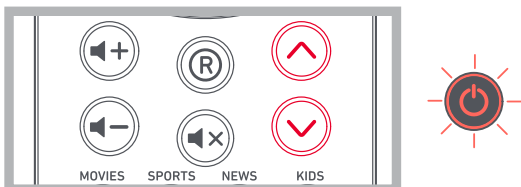

3. Hold down the digit for your brand and device as listed left (e.g. 6 for Samsung TV).
 4. For TV and SKY or Digital Media Box the remote will send Power every 3 seconds until your device switches off . For AV Receiver or Sound Bar the remote will send Mute until your device Mutes volume.
 5. As soon as your device switches off (or mutes), release the digit.
 6. The LED will blink twice and the remote should now operate your device.
- If you find one or more keys do not work as you expect, start again at step 2 – the remote will start with the next code in the memory.

HOW TO SET UP YOUR REMOTE

B - SETUP BY CODE

If the brand of your device is not listed in the SimpleSet feature, you can set up by trying codes individually. To do this:

1. Turn on your device (not on standby) and point the OFA remote towards it.
2. To set up:

TV

Hold down TV Power and SKY Power until the Green LED under the Power key blinks twice.

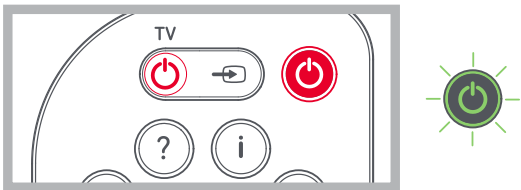

AUDIO RECEIVER, SOUND BAR

Hold down Volume + and Volume - until the Amber LED under the Power key blinks twice.



OTHER SKY / DIGITAL MEDIA BOX

Hold down Channel + and Channel - until the red LED under the Power key blinks twice.



3. Enter the first 4 digit code listed for your brand (e.g. 4142 for Technika).
4. The LED will blink twice.
5. Now aim the remote towards your device and press the Power (or Mute*) key.
6. If the device turns off (or mutes*), your remote is ready to use. If not, repeat steps 2-5 with the next code in the list.

* If you are setting up an Audio Video Receiver or Sound Bar, please try the Mute key during step 5.

AFTER SIMPLESET OF CODE SETUP

Your One For All remote can operate up to three devices. By default the remote is pre-programmed to control your Sky Q box, but you can control some functions of your TV and Sound Bar or Audio Video Receiver

If you set up a TV, the Volume Up, Down, Mute, TV Power and TV Input keys will then control your TV.

If you then also set up an Audio Device such as a Sound Bar or Audio Video Receiver, the remote will then control the Volume Up, Down and Mute of that device.

Power Macro

If you have set up your remote to control more than one device, such as a TV and/or Audio device you can turn them all on or off by simply holding down the Sky Power key for 3 seconds. The remote will first send Power to the Sky Box, and then to TV and Audio (if applicable).

AV Shift

As the AV key is intended to select the input on your TV and most TVs use a menu to select from a list of inputs, when the AV key is pressed and a TV is set up, the Menu Up, Down, Left, Right and OK keys temporarily control the TV. If the OK key is pressed, or no key is pressed for ten seconds, these keys will revert to controlling your Sky Box.

HOW TO SET UP YOUR REMOTE



C - LEARNING

Your One For All remote control can learn any function from any other working remote control. This is a quick and easy one-time setup that allows you to control any infrared controlled device you have in your living room. You can even combine multiple devices in one easy to use remote control – for example you could teach the volume keys to control your Sound Bar, the TV Power and Input keys to control your TV, and the rest of the keys to control a Set Top Box (Satellite, Cable or Freeview Receiver).

To do this, firstly make sure you have all your original remote controls to hand, and that they have working batteries in.

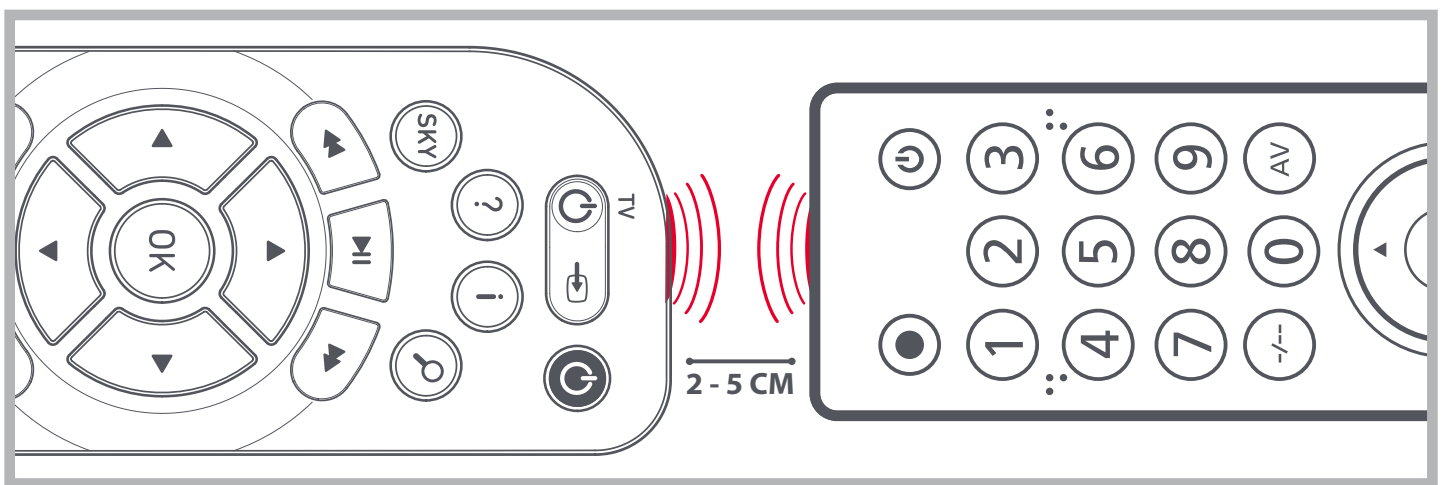
To learn functions, the original remote should be approximately 3cm from the OFA remote, pointing towards it as shown below:

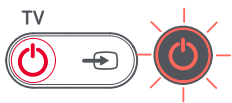
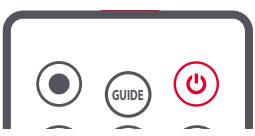

-  1. Hold down 1 and 3 until the red LED blinks twice.
-  2. Press and release the key you want to learn a function onto (for example the TV Power key) – The red LED will blink continuously.
-  3. Press and release* the corresponding key on the original remote, for example Power.
-  4. The red LED will blink twice to indicate the key has been learned correctly.
5. Repeat steps 2 and 3 for each key you want to learn – remember you can learn from multiple remotes, but only one function per key.
-  6. When you have learned all the functions you require, press and hold the OK key until the red LED blinks twice.

Hints:

- If the red LED shows one long blink at step 4, the function was not learned correctly, please try again from step 2.
- If you find one or more keys don't work properly after set up, you can re-enter the learning mode at any time by repeating the procedure from step 1.
- To delete a learned function, hold down **7** (7) and **9** (9) until the red LED blinks twice, and press the key to delete twice.
- If one or more of your original remotes aren't working, you can still set up the One For All remote by SimpleSet (A) or Code Set Up (B).

* Some remotes send commands differently. If you find a function cannot be learned, try holding down the key on the original remote instead of pressing and releasing.

SPECIAL FEATURES

KEY MAGIC

Key Magic is a unique feature to One For All remotes which allows you to add any function from your original remote control to any key on the One For All remote, even if the original remote is lost or broken. So if you find there is a function you frequently use that is not present on the OFA remote, you can select a key to program with this missing function.

In order to program a function, all you need to know is the name of the key on the original remote and the code that you are using to operate your device (or the make and model of your device). Each code has a list of every possible function available for your device, and each of these functions has a 5 digit number associated with it. For example, a Samsung TV uses code 2051 and under that code, the function 00453 represents the "3D" function from the original Samsung remote.

Full lists of functions and their 5 digit codes can be obtained by submitting the details of the device(s) you are controlling and the code(s) you used to program the OFA Remote here <https://www.oneforall.co.uk/webforms/index/index/id/3/> Once you have the function you need, you can program it using the following method (in this example we will be programming the 3D function to the Options key:

TV

Hold down TV Power and SKY Power until the Green LED under the Power key blinks twice.

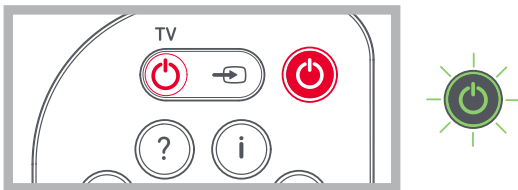

1. Press 9,9,4 (the Green LED will blink twice when the 4 is pressed)

2.

 Enter the 5 digit code for the function (in this case 00453 or 3D)

3. Press the key you want to program the function on (in this case Options)

4. The Green LED will blink twice and the key is now programmed

To program functions for your Set Top Box or Audio device, the procedure is the same, but the first step is different:

AUDIO, RECEIVER, SOUND BAR

Hold down Volume + and Volume - until the Amber LED under the Power key blinks twice.



OTHER SKY / DIGITAL MEDIA BOX

Hold down Channel + and Channel - until the red LED under the Power key blinks twice.





TO RESET THE KEY TO ITS ORIGINAL FUNCTION (OPTIONS IN STB MODE)

OTHER SKY / DIGITAL MEDIA BOX

Hold down Channel + and Channel - until the red LED under the Power key blinks twice.



1.  Press 9, 9, 4 (the Red LED will blink twice when the 4 is pressed)
2.  Hold down the key to reset for 3 seconds (in this case Options)
3.  The red LED will blink twice and the key is now reset.

If the function you want to reset defaults to another device (e.g. TV Power for TV), begin the reset process with the programming step for that device.

TV

Hold down TV Power and SKY Power until the Green LED under the Power key blinks twice.

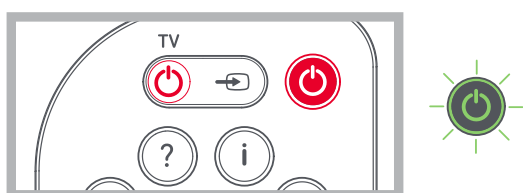

AUDIO, RECEIVER, SOUND BAR

Hold down Volume + and Volume - until the Amber LED under the Power key blinks twice.



CHANNEL SHORTCUT MACROS







By default, the coloured keys on your remote act as they did on the original remote, and also if held down for three seconds, they will send specific channel numbers to the Sky Q box for selecting different genres of channel, such as Movies, Sports etc.

However if you are not using the remote for a Sky Q box, or you would like to change which channels they select, they can be reprogrammed to send channel numbers of your choice. You can even assign multiple channels to a single key so each time you hold the key it will select one of your favourites.

The procedure to program is as follows:



Say for example, the first 3 Sports channels are on channels 200, 221 and 239, you can assign shortcuts to these channels on the Green (Sports) key. To do this:

-  Hold down the Green and the (Sky) Power key until the red LED blinks twice (make sure to press the Green key slightly before the Sky Power or the Sky may turn off)
-  Enter the first channel number (200)
-  Press and release the Green key
-  Enter the next channel number (in this example 221)
- Repeat Steps 3 and 4 for each channel shortcut you want to add
-  After entering the last channel number you want, press and hold the Green key.

The red LED will blink twice and the shortcuts are now programmed. When watching live TV on Sky, simply hold down the Green key for 3 seconds, and the first Channel Shortcut will be sent (in this example channel 200). The next time you hold down the Green Key, the shortcut for the next Channel Shortcut will be sent (in this case channel 221).

You can reprogram each of the different colour keys with different lists of channel numbers, by holding down the Power and a different coloured key at step 1, and pressing and releasing the same key at step 3. Each coloured key has a different name to help you remember the channels that you have stored there. You can program up to 10 different channel numbers per key.

If you wish to reset the key to default, the procedure is as follows:

-  Hold down the key you wish to reset (for example the Green key) and the (Sky) Power key until the red LED blinks twice
-  Press and release the key to reset (for example the Green key)
-  Hold down the same key (e.g. Green) until the red light blinks twice

The key is now reset.







HDMI Selection

In order to view the picture of your Set Top Box, your TV needs to be set to the correct HDMI Input. This is normally done, by pressing the Input key () and then selecting the appropriate input from a list or menu on your TV.

However for some brands of TV, it is possible to reprogram the Input key on the OFA remote to go directly to the specific HDMI Input your Sky Q Box is plugged into, for example HDMI 2. This is called a "discrete command" and can work even if you didn't have a direct key for HDMI 2 on your original remote.

Generally speaking, only the major manufacturers support this, good examples would be Samsung, LG and Sony. You can test whether your TV supports this by performing the following, which will also allow you to set the correct HDMI Input on the Input key on the OFA remote.

Firstly, make sure your One For All remote is already controlling your TV, by following the setup methods A (Simpleset) or B (by Code). Then make sure the TV is a different input from your Sky Q box (for example TV) and:









-    Hold down TV Input and TV Power key until the green LED blinks twice (make sure to press the TV Input key slightly before the TV Power or the TV may turn off)
-  Point toward the TV and press the TV Input key (HDMI 1 should be displayed*)
-  If this is the correct input for your Sky Q Box, press TV Power to store it
-  If not, press the TV Input key again (HDMI 2 should be displayed*)
- Repeat Step 4 if necessary (up to HDMI 4), pressing the TV Power key to store when the right input is displayed.
-  The Green LED will blink twice and from now, the TV Input keys should select the right HDMI Input directly.

* If your TV does not change directly to HDMI 1, 2 or higher on steps 2, 4 or 5, unfortunately this feature may not be supported by your TV.

If you would like to reset the TV Input key back to its original function, you can perform the User Reset in the next section.

User Reset

If you have reprogrammed your remote using Learning, Key Magic, Macros or the HDMI selection feature and you wish to return the remote to the default settings, you can perform the following:

-     Hold down the TV Power and Sky Power keys until the green LED blinks twice
-    Press 9, 8, 0
-  The Green LED will blink 4 times and the remote is now reset

This procedure will reset any programming done, but any devices that have been set up will remain.

PRODUCT DISPOSAL

(EUROPEAN DIRECTIVE 2002/96/EC)

The crossed out wheeled bin symbol on this product ensures that this product is manufactured using high quality components that can be recycled and reused according to European Directive 2002/96/EC. Please do not dispose this product with your normal household waste but inform yourself about the local separate collection for electrical and electronic products to dispose this product correctly. This will help preventing potential negative effects on the environment and/or human health.

BATTERY DISPOSAL AND SAFETY

(EUROPEAN DIRECTIVE 2006/66/EC)

Please do not dispose your batteries with your normal household waste but inform yourself about the local separate collection for empty batteries to dispose them correctly. This will help preventing potential negative effects on the environment and/or human health.

Keep batteries away from fire, out of direct sunlight, and away from other sources of heat.

UNIVERSAL ELECTRONICS INC/ONE FOR ALL warrants to the original purchaser that this product will be free from defects in materials and workmanship under normal and correct use for a period of one (1) year from the date of original purchase. This product will be replaced free of charge if it has been proven to be defective within the one (1) year warranty period. This warranty does not cover cartons, carrying cases, batteries, broken or marred cabinets or any other item used in connection with the product. Any further obligation than listed above is excluded. Please notice that we need your purchase receipt so that we may establish your eligibility for service. If you have bought this product for purposes which are not related to your trade, business or profession, please remember that you may have legal rights under your national legislation governing the sale of consumer goods. This guarantee does not affect those rights.



Universal Electronics BV –
Europe & International
P.O. Box 3332, 7500 DH Enschede The Netherlands

